

EUROCABOS 623 - SINAL Receptáculo angular M23

DADOS TÉCNICOS

Números de polos	12
Faixa de temperatura	-20 °C à 130 °C
Grau de proteção	IP67 quando conectado

DADOS ELÉTRICOS

Corrente nominal	7A
Tensão nominal	250 VAC
Resistência isolação	>1000 ΩM À 500VDC
Resistência a tensão	1500 VAC

MATERIAIS

Corpo do conector	Zinc diecast / nickel plated
Inserto	Nylon UL94V-0
Selo	EPDM

Valores de acordo com VDE 0110 / EN 61984, parte 6.19.2.2

Grau de poluição	3
Categoria de sobretensão	III
Altura max. de operação	2000m

Inserto Code 0°
Corpo Code 1
Flange 28x28
Anti-vibração o-ring
Rosca externa M23x1

SC-623 A12P 002 SN 0E10

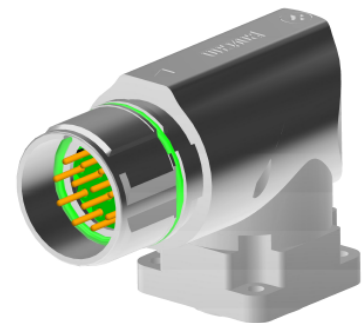

12-pin E
(12 x Ø 1 mm)

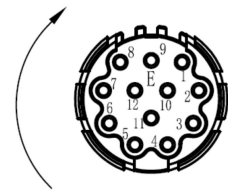

Mating view

Contato pino crimp Ø1mm - Crimping range: 0.14 - 1.0mm² **

Material: Liga de cobre / Área de contato: Ouro

FM230010011

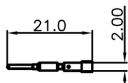

Contato soquete crimp Ø1mm - Crimping range: 0.14 - 1.0mm² **

Material: Liga de cobre / Área de contato: Ouro

FM230003D22

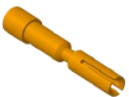

**Contatos não fazem parte do produto, vendido separadamente

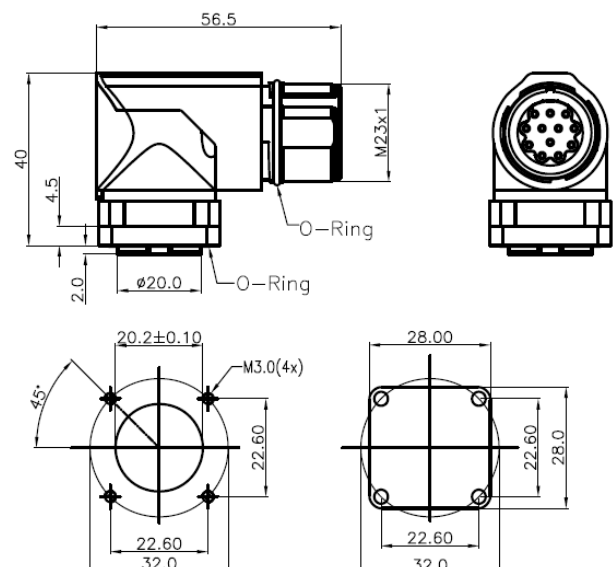

EUROCABOS
623 - SINAL
Receptáculo angular M23
INSTRUÇÃO DE MONTAGEM

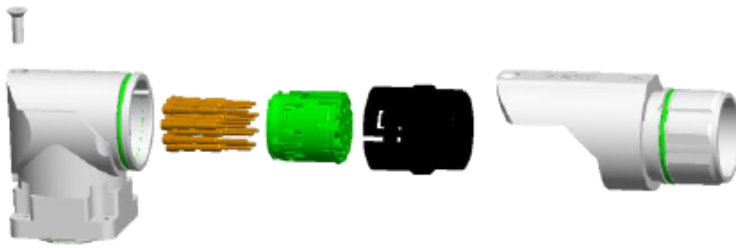

①



②

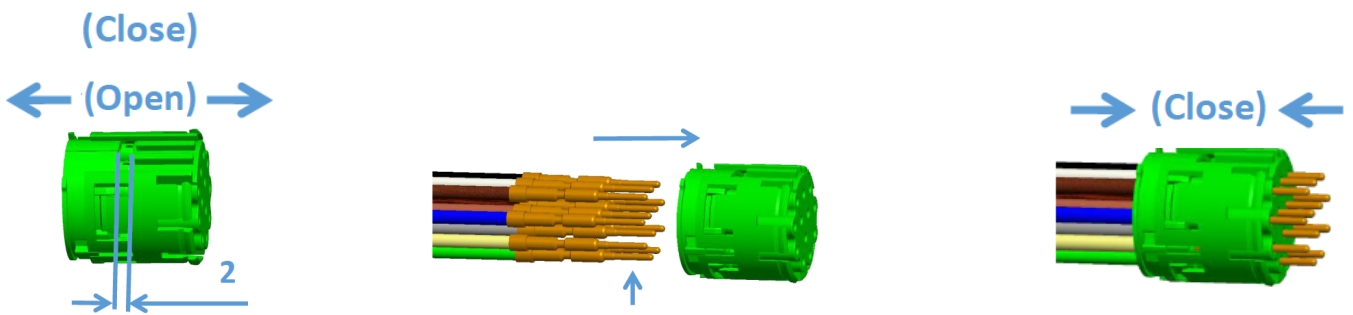

Atenção a posição dos contatos

③

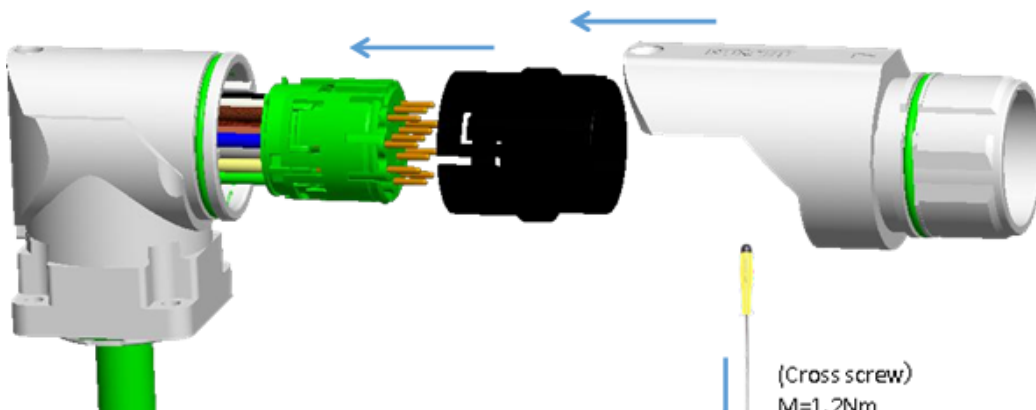

④

