

LEONI Part No.: **95040143A**

LEC 003719 Rev.0

construction

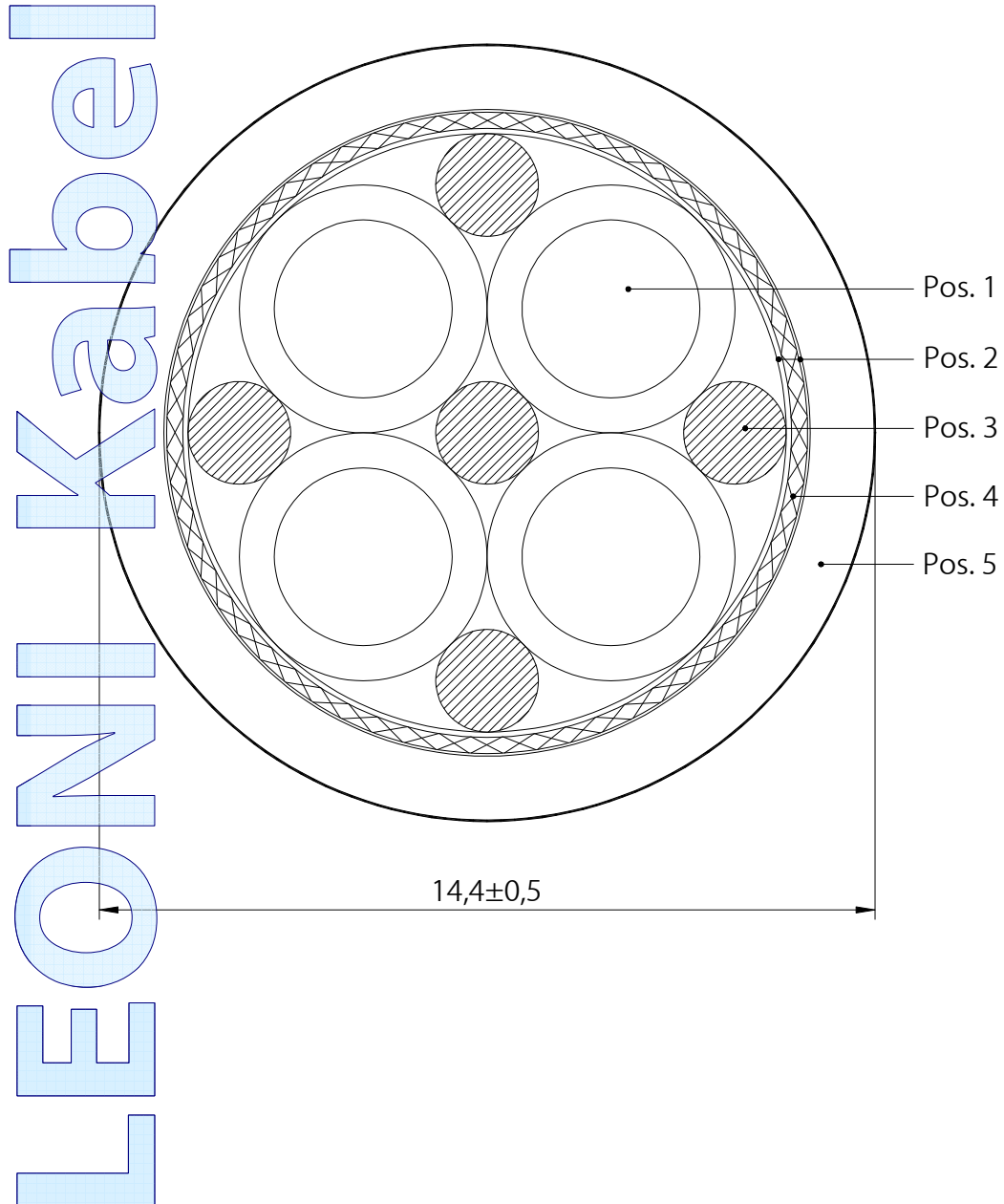

Weitergabe an Dritte nur mit Genehmigung der Fa. LEONI Kabel GmbH - Alle Rechte vorbehalten -
 Transfer to third party only by authority of LEONI Kabel GmbH
 Nur gültig zum Zeitpunkt des Ausdrucks. Bei Wiederverwendung Aktualität prüfen – Nur zur Information
 Valid only at time of printing. In case of re-use check issue – Only for Information

LEONI Kabel

All indications on this data sheet have been made to the best of our knowledge. They are only a not binding advice and serve as a starting point for plannings. They don't release the user from own tests regarding the suitability of the desired application purposes. Processing and use of the products cannot be controlled by us and are therefore exclusively in your field of responsibility. Subject to alterations if new realization will make it necessary.

LEONI Part No.: **95040143A**

LEC 003719 Rev.0

cable description

Pos. 1 4 insulated wires 6,0 mm²

conductor

bare copper, single wire 0,20 mm
in accordance to DIN EN 60228 cl. 6 / IEC 60228 cl. 6
PP
black wires with white marking U/L1/C/L+,
V/L2, W/L3/D/L-, greenyellow



insulation
colours

Pos. 2

tapings

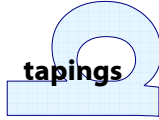

Pos. 3

filler

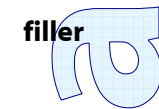

Pos. 4

shielding

braiding of tinned copper wires 0,15 mm
optical covering min. 85 %

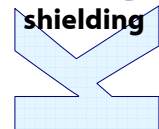

Pos. 5

outer jacket

Polyurethan in accordance to DIN VDE 0282 Teil 10
/ HD22.10 S2
orange mat following RAL 2003
LEONI LRO FieldLink MC LEC 003719 Rev.0
[4x6,0] XX/YYYY
E47543 e AWL US AWM STYLE 21223 I/II A/B 80°C 1000V FT-1
VDE-REG.NR. 8407
production week
production year
14,5 ± 0,5 mm

colour
overprint in black with Inkjet

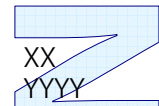
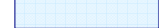

XX
YYYY

outer diameter

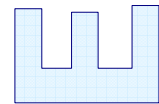
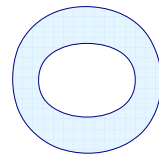

Weitergabe an Dritte nur mit Genehmigung der Fa. LEONI Kabel GmbH - Alle Rechte vorbehalten -
Transfer to third party only by authority of LEONI Kabel GmbH
Nur gültig zum Zeitpunkt des Ausdrucks. Bei Wiederverwendung Aktualität prüfen - Nur zur Information
Valid only at time of printing. In case of re-use check issue - Only for Information

All indications on this data sheet have been made to the best of our knowledge. They are only a not binding advice and serve as a starting point for plannings.
They don't release the user from own tests regarding the suitability of the desired application purposes.
Processing and use of the products cannot be controlled by us and are therefore exclusively in your field of responsibility.
Subject to alterations if new realization will make it necessary.

LEONI Part No.: **95040143A****LEC 003719 Rev.0****Electrical properties**

operating voltage	Pos. 1	U_0/U	0,6/1,0 kV
test voltage	Pos. 1 according to  conductor/conductor	max.	1000 V
	conductor/shield		4,0 kV 50Hz AC
conductor resistance			4,0 kV 50Hz AC
		max.	3,30 Ω /km at +20°C

Mechanical properties

bending radius for fixed installation		min.	5 x outside diameter
	for drag chain installation	min.	110 mm
acceleration		max.	50 m/s ²
traversing speed		max.	300 m/min
bendings in drag chains		min.	10.000.000
torque at a length of 1000 mm		max.	± 30 degree
horizontal length of the cable		max.	50 m
total weight		nom.	394 kg/km

Thermal properties

treatment and installation			-20°C bis +60°C
transport and stocking			-50°C bis +80°C
operating for fixed installation			-50°C bis +80°C
for drag chain installation			-20°C bis +60°C
short cut		max.	+150°C (≤ 5 sec.)

Chemical properties

oil resistant in accordance to VDE 0282 part 10 / HD 22.10 S2 (test method to EN60811-2-1)
 flame retardant in accordance to UL 1581 Vertical Wire Flame Test (VW-1)
 flame retardant in accordance to CSA C22.2 Vertical Flame Test (FT-1)
 flame retardant in accordance to IEC 60332-1-2
 halogen free in accordance to EN 50267-2-2 / IEC 60754-2
 free of silicon and FCKW



the cable corresponds to EU – directive 2002/95/EG (RoHS)

All indications on this data sheet have been made to the best of our knowledge. They are only a not binding advice and serve as a starting point for plannings.
 They don't release the user from own tests regarding the suitability of the desired application purposes.
 Processing and use of the products cannot be controlled by us and are therefore exclusively in your field of responsibility.
 Subject to alterations if new realization will make it necessary.

LEONI Part No.: **95040143A**

LEC 003719 Rev.0

Standard

UL Subject 758; Style 21223 and and CSA - C22.2 No. 210

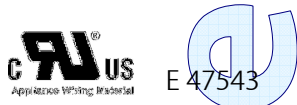

Cable is approved to UL Style 21223 80°C 1000V VW-1 and cUL AWM I/II A/B 80°C 1000V FT-1

Weitergabe an Dritte nur mit Genehmigung der Fa. LEONI Kabel GmbH - Alle Rechte vorbehalten -
 Transfer to third party only by authority of LEONI Kabel GmbH
 Nur gültig zum Zeitpunkt des Ausdrucks. Bei Wiederverwendung Aktualität prüfen – Nur zur Information
 Valid only at time of printing. In case of re-use check issue – Only for Information

LEONI KABEL

All indications on this data sheet have been made to the best of our knowledge. They are only a not binding advice and serve as a starting point for plannings.
 They don't release the user from own tests regarding the suitability of the desired application purposes.
 Processing and use of the products cannot be controlled by us and are therefore exclusively in your field of responsibility.
 Subject to alterations if new realization will make it necessary.