

LEONI Part No.:
LEHC 004694 Rev.0

Construction

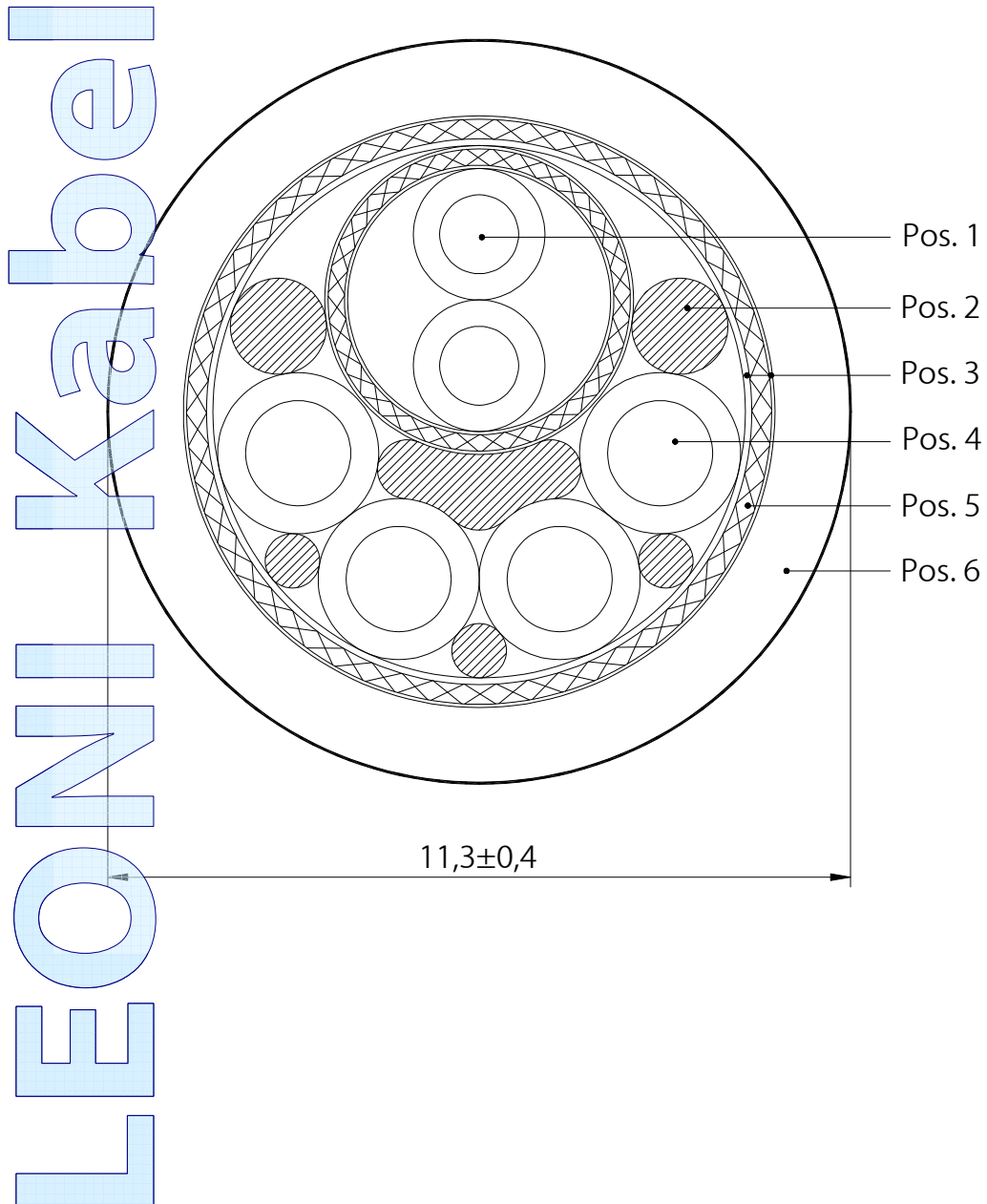

Weitergabe an Dritte nur mit Genehmigung der Fa. LEONI Kabel GmbH – Alle Rechte vorbehalten -
 Transfer to third party only by authority of LEONI Kabel GmbH
 Nur gültig zum Zeitpunkt des Ausdrucks. Bei Wiederverwendung Aktualität prüfen – Nur zur Information
 Valid only at time of printing. In case of re-use check issue – Only for Information

All indications on this data sheet have been made to the best of our knowledge. They are only a not binding advice and serve as a starting point for plannings. They don't release the user from own tests regarding the suitability of the desired application purposes. Processing and use of the products cannot be controlled by us and are therefore exclusively in your field of responsibility. Subject to alterations if new realization will make it necessary.

LEONI Part No.:
LEHC 004694 Rev.0

Cable description

Pos. 1 shielded pair 2x1,0 mm²



bare copper, single wire 0,15 mm
 in accordance to DIN EN 60228 cl. 6 / IEC 60228 cl. 6
 PP
 white and black,
 braiding of tinned copper wires 0,128 mm
 optical covering min. 85 %

Pos. 2 filler

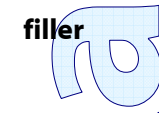

Pos. 3 tapings



Pos. 4 4 insulated wires 1,5 mm²

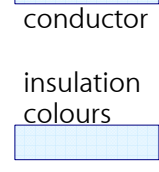

bare copper, single wire 0,15 mm
 in accordance to DIN EN 60228 cl. 6 / IEC 60228 cl. 6
 PP
 black wires with white marking U/L1/C/L+,
 V/L2, W/L3/D/L-, greenyellow

Pos. 5 shielding

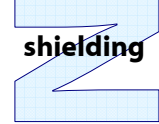

braiding of tinned copper wires 0,15 mm
 optical covering min. 85 %

Pos. 6 outer jacket

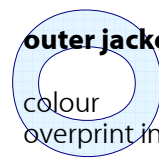

Polyurethan in accordance to DIN VDE 0282 Teil 10
 / HD22.10 S2
 orange mat following RAL 2003
 LEONI LRO FieldLink MC LEHC 004694 Rev.0
 [4x1,5+(2x1,0)] XX/YYYY
 E47543 e AWL AWM STYLE 21223 I/II A/B 80°C 1000V FT-1
 production week
 production year
11,3 ± 0,4 mm

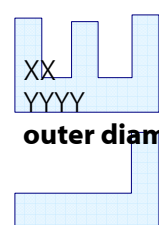



outer diameter

Weitergabe an Dritte nur mit Genehmigung der Fa. LEONI Kabel GmbH – Alle Rechte vorbehalten -
 Transfer to third party only by authority of LEONI Kabel GmbH
 Nur gültig zum Zeitpunkt des Ausdrucks. Bei Wiederverwendung Aktualität prüfen – Nur zur Information
 Valid only at time of printing. In case of re-use check issue – Only for Information

All indications on this data sheet have been made to the best of our knowledge. They are only a not binding advice and serve as a starting point for plannings.
 They don't release the user from own tests regarding the suitability of the desired application purposes.
 Processing and use of the products cannot be controlled by us and are therefore exclusively in your field of responsibility.
 Subject to alterations if new realization will make it necessary.

LEONI Part No.:
LEHC 004694 Rev.0

Electrical properties

operating voltage	Pos. 4	U_0/U	0,6/1,0 kV
	Pos. 4 according to 	max.	1000 V
	Pos. 1	max.	24 V
test voltage	Pos. 1 according to 	max.	1000 V
	Pos. 4 conductor/conductor		4,0 kV 50Hz AC
	Pos. 4 conductor/shield		4,0 kV 50Hz AC
	Pos. 1 conductor/conductor		4,0 kV 50Hz AC
	Pos. 1 conductor/shield		4,0 kV 50Hz AC
conductor resistance	Pos. 1	max.	19,5 Ω /km at +20°C
	Pos. 4	max.	13,3 Ω /km at +20°C

Mechanical properties

bending radius for fixed installation		min.	5 x outside diameter
	for drag chain installation	min.	7,5 outside diameter
acceleration		max.	50 m/s ²
traversing speed		max.	300 m/min
bendings in drag chains		min.	10.000.000
torque at a length of 1000 mm		max.	± 30 degree
horizontal length of the cable		max.	50 m
total weight		nom.	208 kg/km

Thermal properties

treatment and installation		-20°C bis +60°C
transport and stocking		-50°C bis +80°C
operating	for fixed installation	-50°C bis +80°C
	for drag chain installation	-20°C bis +60°C
short cut		max. +150°C (≤ 5 sec.)

Weitergabe an Dritte nur mit Genehmigung der Fa. LEONI Kabel GmbH – Alle Rechte vorbehalten -
 Transfer to third party only by authority of LEONI Kabel GmbH
 Nur gültig zum Zeitpunkt des Ausdrucks. Bei Wiederverwendung Aktualität prüfen – Nur zur Information
 Valid only at time of printing. In case of re-use check issue – Only for Information

All indications on this data sheet have been made to the best of our knowledge. They are only a not binding advice and serve as a starting point for plannings.
 They don't release the user from own tests regarding the suitability of the desired application purposes.
 Processing and use of the products cannot be controlled by us and are therefore exclusively in your field of responsibility.
 Subject to alterations if new realization will make it necessary.

LEONI Part No.:
LEHC 004694 Rev.0

Chemical properties

oil resistant in accordance to VDE 0282 part 10 / HD 22.10 S2 (test method to EN60811-2-1)
flame retardant in accordance to UL 1581 Vertical Wire Flame Test (VW-1)
flame retardant in accordance to CSA C22.2 Vertical Flame Test (FT-1)
flame retardant in accordance to IEC 60332-1-2
halogen free in accordance to EN 50267-2-2 / IEC 60754-2
free of silicon and FCKW



the cable corresponds to EU – directive 2002/95/EG (RoHS)

Standard

UL Subject 758; Style 21223 and and CSA - C22.2 No. 210



E 47543

Cable is approved to UL Style 21223 80°C 1000V VW-1 and cUL AWM I/II A/B 80°C 1000V FT-1

Weitergabe an Dritte nur mit Genehmigung der Fa. LEONI Kabel GmbH – Alle Rechte vorbehalten -
Transfer to third party only by authority of LEONI Kabel GmbH
Nur gültig zum Zeitpunkt des Ausdrucks. Bei Wiederverwendung Aktualität prüfen – Nur zur Information
Valid only at time of printing. In case of re-use check issue – Only for Information

All indications on this data sheet have been made to the best of our knowledge. They are only a not binding advice and serve as a starting point for plannings.
They don't release the user from own tests regarding the suitability of the desired application purposes.
Processing and use of the products cannot be controlled by us and are therefore exclusively in your field of responsibility.
Subject to alterations if new realization will make it necessary.